

Article number: 25018464002

Description: ICME Single-phase motor MD63 B4 0,18KW
4 - 1400 rpm 1x230 Volt 50Hz B5 with starting & running capacitor

Measures

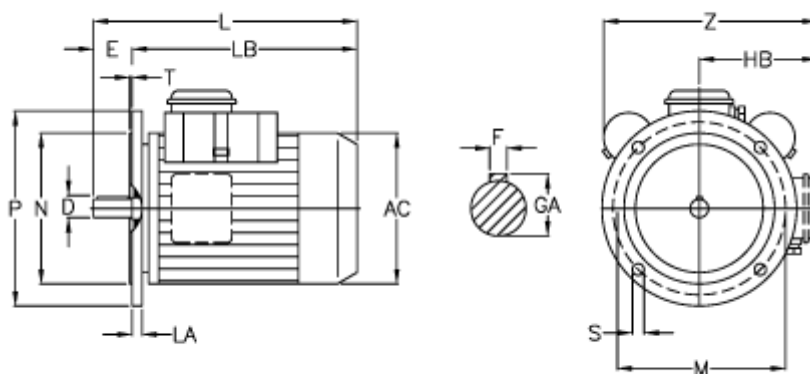

AC = 124	LB = -
D = 11	M = 115
E = 23	N = 95
F = 4	P = 140
GA = 12.5	S = 9.5
HB = -	T = 3.0
L = 211	Z = -
LA = 10.0	